

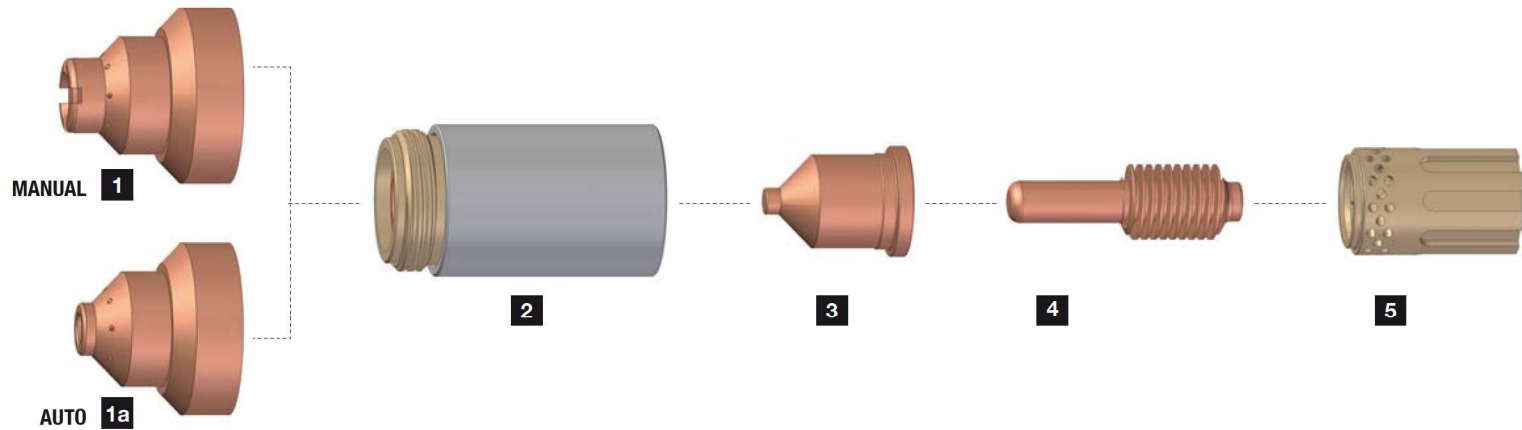

Soluzione in blister - Blister's solution - Solution en blisters - Solución en blister

Powermax 1000®	(T60M)
Powermax 1250®	(T80M)
Powermax 1650®	(T100/M/M-2)





CODE		A	1000	1250	1650	REF	Pcs X 	 X 
------	--	---	------	------	------	-----	--	---



1 SCHERMO MAN - SHIELD MAN - PATIN MAN - ESCUDO MAN

CV0176P		40 60 80	•	•	•	T120929H	1	2
CV0178P		100			•	T220065H	1	2





1a SCHERMO AUT - SHIELD AUT - PATIN AUT - ESCUDO AUT

CV0177P		40 60 80	•	•	•	T120930H	1	2
CV0179P		100			•	T220047H	1	2

2 UGELLO PORTA SCHERMO - RETAINING CAP - BUSE PROTECTION - TOBERA DE RETENCIÓN

PC0234P		40 60 80	•	•	•	T120928H	1	2
PC0233P		100			•	T220048H	1	2

3 CAPPA - NOZZLE - TUYÈRE - BOQUILLA



PD0234P10		40	•	•	•	T120932H	5	2
PD0234P12		60	•	•	•	T120931H	5	2
PD0234P14		80		•	•	T120927H	5	2
PD0233P16		100			•	T220011H	5	2

CODE		A	1000	1250	1650	REF	Pcs X 	 X 
------	--	---	------	------	------	-----	--	---

4 ELETTRODO - ELECTRODE - ELECTRODE - ELECTRODO

PR0234P		40 60 80	•	•	•	T120926H	5	2
PR0233P		100			•	T220037H	5	2

5 DIFFUSORE VESPEL - SWIRL RING VESPEL - DIFFUSEUR VESPEL - DIFFUSOR VESPEL

PE0234P		40 60 80	•	•	•	T120925H	1	2
PE0233P		100			•	T220051H	1	2